



THE OUTDOOR
GREATROOM
COMPANY

The Cove Fire Pit

Installation Instructions for CV-2424



IMPORTANT

Please consult your Crystal Fire® Plus instruction manual for detailed instructions and important information related to hooking up your burner, including safety information, proper tightening of connections with two wrenches and full burner setup and lighting instructions.

DO NOT ATTEMPT TO INSTALL CFP2424 BURNER WITHOUT FIRST CONSULTING THE CRYSTAL FIRE® PLUS OWNER'S MANUAL.

Contents

Required Tools.....	3
Included With Your Fire Pit.....	4
Assembly Instructions.....	5
CF-SPARKER Installation.....	5
Gas Connections.....	6
Thermocouple Installation.....	6
Electrode Installation.....	7
Propane Tank Installation.....	8
Install Fire Media.....	9
Operating Instructions.....	10

Required Tools

THREE people are required for this installation.



- 2 Open Ended Wrenches
To secure gas connections.



- Leather Gloves
To protect hands from rough edges found on fire pit during installation.



- One AAA Battery (not included)
Required for electric spark igniter installation.





- Utility Knife
To cut and remove packaging.

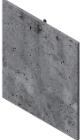

- Power Drill
To remove support board from crate.

Included With Your Fire Pit

	<p>Cove 2424 Base with Key Valve Control Panel Installed</p> <p>(CV-2424-BASE) (KV-CP-BLK)</p>
	<p>Cove 2424 Door</p> <p>(CV-2424-DOOR)</p>
	<p>Black Key</p> <p>(BF-KY-05)</p>
	<p>24" x 24" Crystal Fire® Plus Burner Kit with black trim</p> <p>(CFP2424-BLK)</p>

Refer to Crystal Fire® Plus Manual for items included with Crystal Fire® Plus burners.

Assembly Instructions

1. Remove Cove-2424-Base from Packaging crate

- Remove side panels from crate using a power drill with Philips head bit.
- Three People are required to lift base out of packaging and place into final location. CAUTION: Base is heavy, take all necessary precautions to prevent injury during installation.

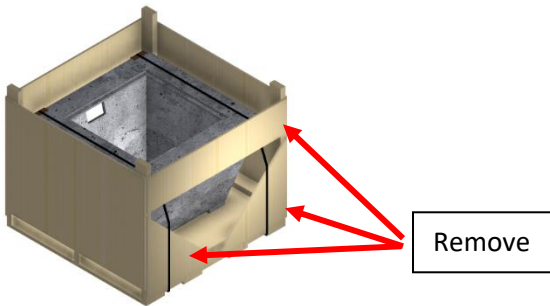

1. CF-SPARKER Installation

- Locate CF-SPARKER inside of crystal fire burner box.
- Remove CF-SPARKER cap and hex nut. Insert AAA battery (not included) with + end out.
- Install CF-SPARKER into control panel as shown below.
- Depress CF-SPARKER button to test your sparker.

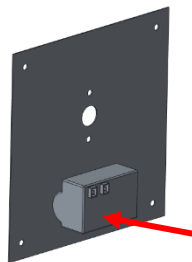
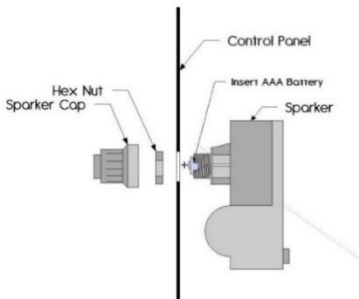

Locate and orient sparker box on control panel as shown. Sparker box must be installed **before** burner valve.

2. Gas Connections

Read and understand your Crystal Fire Burner Owner's manual before beginning burner hookups or using the device.
Do not use Teflon tape or pipe dope on flare fittings.

- See Crystal Fire® Plus instructions for burner installation.
 - All gas connections were completed at the factory.
- Check all connections for leaks. If needed, tighten connection with 2 wrenches and re-check for leaks.
- Attach burner valve to control panel with provided screws as shown below. Ensure sparker box is installed before this step.

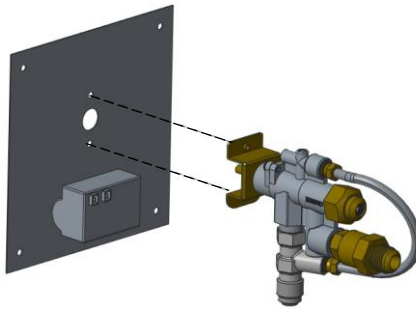

3. Thermocouple Installation

- Refer to Crystal Fire® Plus instruction manual for detailed attachment of thermocouple.
- Attach thermocouple to burner valve as shown below.

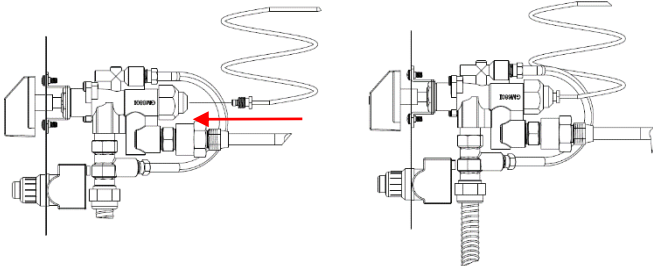

4. Electrode Installation

- Connect igniter and ground wire to sparker box. Both wires can connect to either connection point. The unit will operate in either configuration.
- Test system by pushing the button on the igniter. Consult the troubleshooting section of the Crystal Fire® Plus Burner Owner's Manual, if the spark is weak, intermittent, or not present.

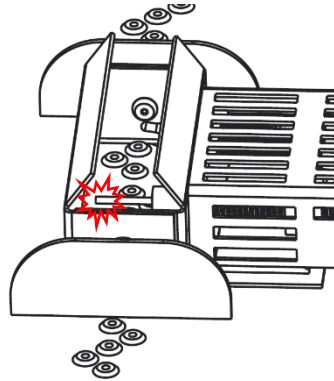
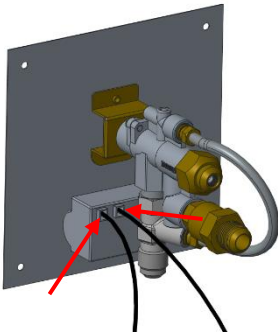

5. Propane Tank Installation



- With the propane tank valve and key valve off, attach the propane regulator to the propane tank. **Hand tighten, do not use a wrench for this connection.**



- Lift and tilt the propane tank through the access door into place underneath the base. Ensure that all hoses and wires are kept away from the hot burner surfaces. Use caution not to chip the edges of the concrete when installing the tank.

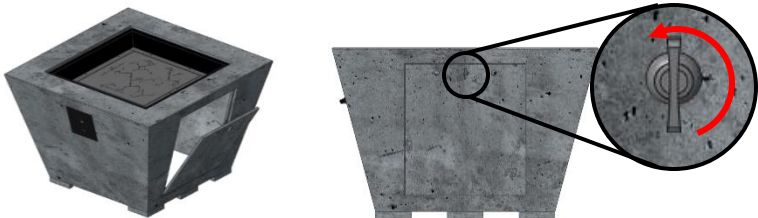

- Install the door by setting the bottom edge in place and tilting into place. Secure by turning the $\frac{1}{4}$ turn cam lock to lock the door in place.

6. Install Fire Media

- a. Scatter all included glass beads, lava rock, or other approved fire media evenly across entire burner surface.

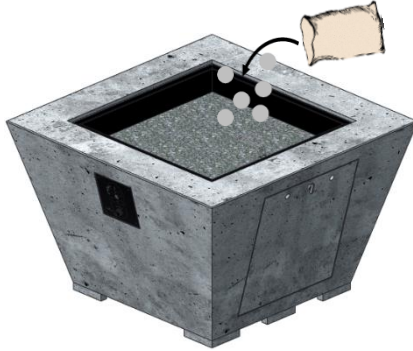

**DO NOT OPERATE CRYSTAL FIRE® PLUS BURNER
WITHOUT INCLUDED GLASS BEADS OR OTHER
APPROVED FIRE MEDIA**

**DO NOT OPERATE CRYSTAL FIRE® PLUS BURNER
WITH BURNER COVER IN PLACE**

IMPORTANT

Please consult your Crystal Fire® Plus instruction manual for detailed instructions and important information related to hooking up your burner, including safety information, proper tightening of connections with two wrenches and full burner setup and lighting instructions.

**DO NOT ATTEMPT TO INSTALL CFP2424 BURNER WITHOUT FIRST
CONSULTING THE CRYSTAL FIRE® PLUS OWNER'S MANUAL.**

WARNING

**After consulting the manual and following instructions, remember; before
operating, all gas connections must be fully checked for leaks**

7. Operating Instructions

Before operating your Cove 2424 fire pit, ensure all gas connections are properly tightened and thoroughly leak checked. Refer to the Crystal Fire® Plus Manual for information on proper leak checking and other critical safety information.

- Verify control valve is in OFF position. If operating on a self-contained propane cylinder, ensure cylinder valve is CLOSED. If operating on a hard-piped system, ensure main gas supply shut-off valve and all other valves in gas system are OPEN.
- If operating on a self-contained propane cylinder, slowly open cylinder valve.
- Press and hold sparker button. Verify an audible and visible spark is present within the ignition wind guard.
- Gently press and turn control knob to LOW/IGNITION position. Fully depress control knob and hold for 3-5 seconds. Burner should ignite and continue to operate when control knob is released.
- If burner does not light or remain lit after 20 seconds of attempting ignition, turn control valve to OFF position and wait 5 minutes to allow gas to dissipate before attempting ignition again. **DO NOT ATTEMPT TO LIGHT BURNER IF YOU SMELL GAS.**
- With burner lit and operating, the flame height can be adjusted between LOW and HIGH at any time.
- While depressing the sparker, use the key to open the key valve.

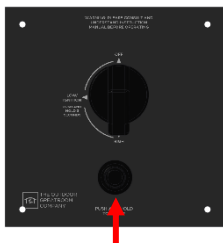

1. Depress sparker

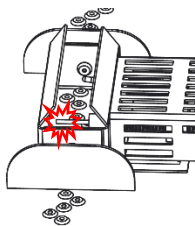

2. Look/listen for spark

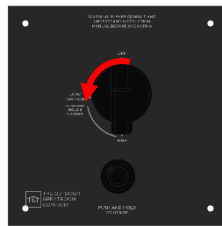

3. Turn valve to ON

Refer to the Crystal Fire® Plus Manual included with your burner for more detailed information on operation, maintenance, and safety of your burner.



WARNING: This product can expose you to chemicals including Carbon Monoxide and Benzene which are known to the State of California to cause cancer or birth defects or reproductive harm. For more information, visit www.P65Warnings.ca.gov

Thank you for purchasing an
Outdoor GreatRoom Company
product! This fire pit was made with
pride in the USA.



Warranty: Fire pit tables are covered under a 1- year
manufacturer's warranty. Please visit
<https://www.outdoorrooms.com/product-registration>
to register your product.

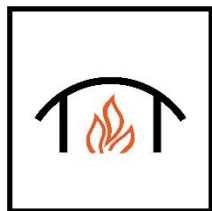

9583 217th St. W. • Lakeville, MN 55044
Toll Free: 1-866-303-4028 • Sales@OutdoorRooms.com